

Designed to comply with physical, electrical and environmental requirements of Micro USB Standard (USB2.0)  
A/B types support USB On-The-GO (OTG) interface.

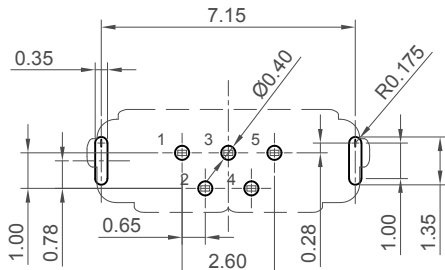

**Recommended PCB Layout**  
As viewed from component side General Tolerance: ±0.05  
□ Component Outline

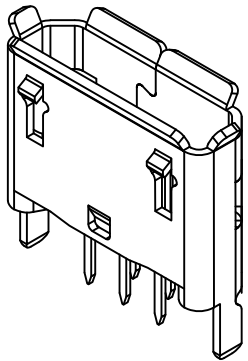
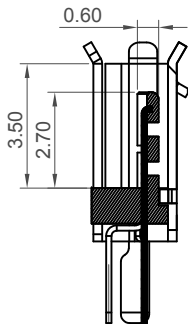

**Section A:A**

**Ordering Grid**  
**USB3131 - 30 - 0230 - A** [Request Samples and Quotation](#)  
 Contact Plating  
 30 = 30µ" Gold  
 Shell Stake Length "S"  
 0230 = 2.30mm  
 (recommended for 1.6mm PCB thickness)  
 Packing Options  
 A = Tape & Reel  
 (1,500 Pieces per Reel)

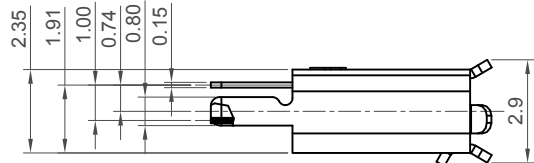

**Specifications:**

**Materials:**

- Plastic Housing: LCP, UL94V-0, Black
- Contact Terminal: Copper Alloy
- Metallic Shell: Stainless Steel SUS304-1/2H T=0.25mm

**Plating:**

- Underplating: Nickel 50µ" min.
- Contact Area: 30µ" Gold plating
- Solder Tails: Gold Flash
- Metallic Shell: Nickel 50-100µ"

**Electrical:**

- Voltage Rating: 30V
- Current Rating: Signal (Pins 2,3,4): 1.0 A  
Power (Pins 1,5): 1.8 A
- Operating Temperature : -55°C to +85°C
- Contact Resistance: 30 mΩ max.
- Insulating Resistance: 1000 MΩ min.
- Dielectric Withstand Voltage: 100V AC for 1 minute

**Mechanical & Environmental**

- Mating Force: 35N max.
- Unmating Force: Initial 10N min.  
Final 8N min after durability test.
- Durability: 10,000 Cycles

Part Number		Product Description	
USB3131		Micro USB Receptacle, Type B, Through-Hole, Vertical, With 2.30mm (Standard) Shell Stakes	
Drawing Date		28th October 2013	
By	CC	Tolerances (Except as Noted)	Units:
Detail	USB3131 B PCN	Length	Metric (mm)
Revision	B5	Angle	
Date	07/10/20	X.X ± 0.35	
		X.XX ± 0.25	
		This drawing is confidential and copyright of Global Connector Technology, Ltd (GCT). This drawing must not be copied or disclosed without written consent. E & OE	



Not to Scale	Drawn By AJO	Sheet No. 1/2
--------------	--------------	---------------

H  
G  
F  
E  
D  
C  
B  
A

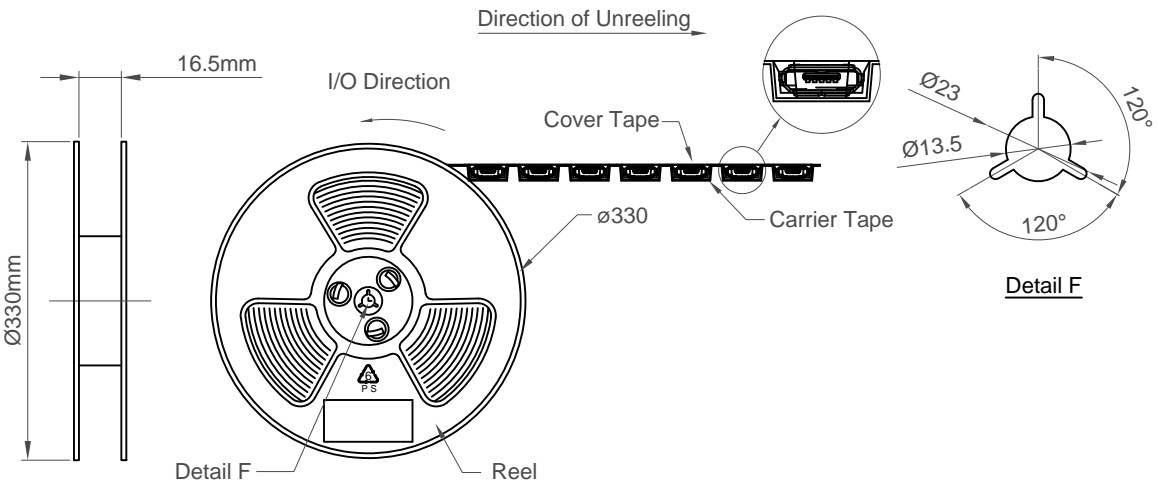
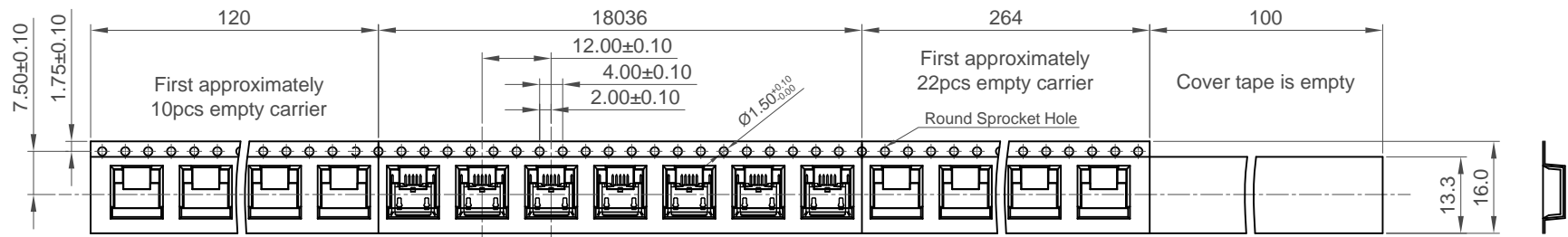

Products P/N	PCS/Reel	Reels/Carton	PCS/Carton
USB3131	1,500	10	15,000

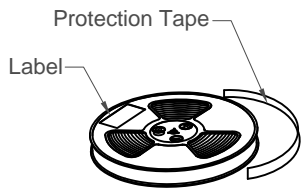

1,500 Pieces/Reel

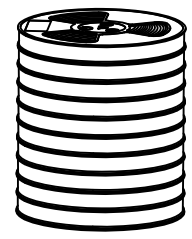

10 Reels

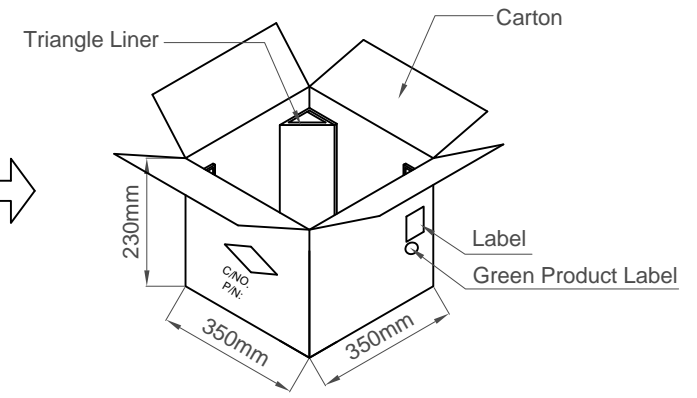
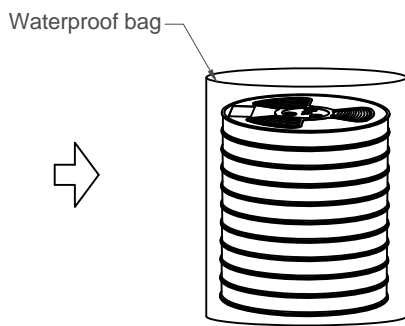

Part Number		Product Description	
USB3131		Micro USB Receptacle, Type B, Through-Hole, Vertical, With 2.30mm (Standard) Shell Stakes	
Drawing Date		28th October 2013	
By	CC	Tolerances (Except as Noted)	Units:
Detail	USB3131 B PCN	Length	Metric (mm)
Revision	B5	Angle	
Date	07/10/20		



This drawing is confidential and copyright of Global Connector Technology, Ltd (GCT). This drawing must not be copied or disclosed without written consent. E & OE



Not to Scale	Drawn By AJO	Sheet No. 2/2
--------------	-----------------	------------------

1 2 3 4 5 6 7 8