

Recommended PCB Layout
Thickness=0.80mm

As viewed from component side Tolerance:±0.05mm

▨ Solder Area □ Component Outline

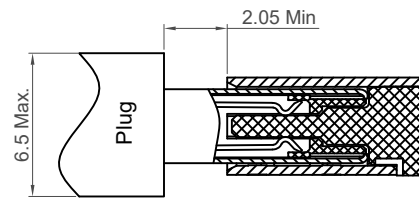
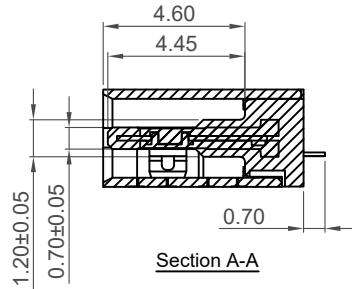
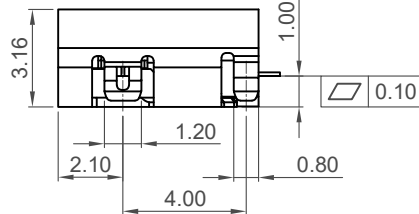

Pin	Signal	Mating Sequence	Pin	Signal	Mating Sequence
A1	GND	First	B12	GND	First
A4	Vbus	First	B9	Vbus	First
A5	CC1	Second	B8	SBU2	Second
A6	Dp1	Second	B7	Dn2	Second
A7	Dn1	Second	B6	Dp2	Second
A8	SBU1	Second	B5	CC2	Second
A9	Vbus	First	B4	Vbus	First
A12	GND	First	B1	GND	First
SHELL	GND		SHELL	GND	

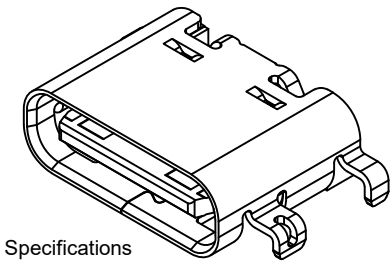

Specifications

Material

Insulator: PA9T, UL 94V-0, Black
Contact: Copper Alloy, C18400-H, T=0.12mm
Shell: Stainless steel, SUS304-1/2H, T=0.30mm
Mid Plate: Stainless Steel, SUS301-3/4H, T=0.15mm

Plating

Terminal:

Contact Area: See Ordering Grid
Solder Tails: Gold Flash
Underplating: 50µ" Min. Nickel Over All
Shell: 30µ" Min. Nickel
Mid Plate: Clear

Electrical

Current Rating: 5.00A collectively for Vbus pins
6.25A collectively for GND pins
1.25A for A5/B5 pin
0.25A per pin for all other pins

Voltage Rating: 48V DC

Power Rating: 240W

Contact Resistance: 40mΩ max initial.

50mΩ max after test

Dielectric Withstanding Voltage: 100V AC

Insulation Resistance 100MΩ min

Mechanical & Environmental

Operating Temperature: -25°C to +85°C

Mating Force: 5 to 20 N.

Unmated Force: 6 to 20 N after test

Durability: 20,000 cycles

Ordering Grid

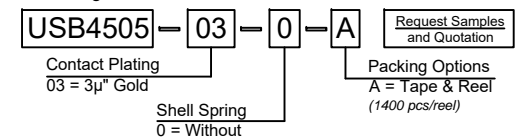

Part Number		Product Description	
USB4505		USB Type C Receptacle for USB 2.0, SMT Type, Mid Mount, 1.0mm Offset	
Drawing Date		1st July 2021	
By	CC	Tolerances (Except as Noted)	Units:
Detail	Drawing Release	Length	Metric (mm)
Revision	A2	X.X ± 0.30	
Date	18/12/23	X.XX ± 0.20	
		X.XXX ± 0.10	



This drawing is confidential and copyright of Global Connector Technology, Ltd (GCT). This drawing must not be copied or disclosed without written consent. E & OE



Not to Scale	Drawn By CC	Sheet No. 1/2
--------------	----------------	------------------

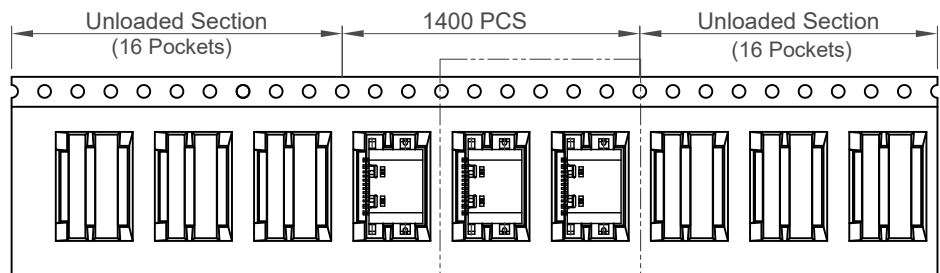

Direction of Unreeling

Detail E

Peeling Angle 165°~180°

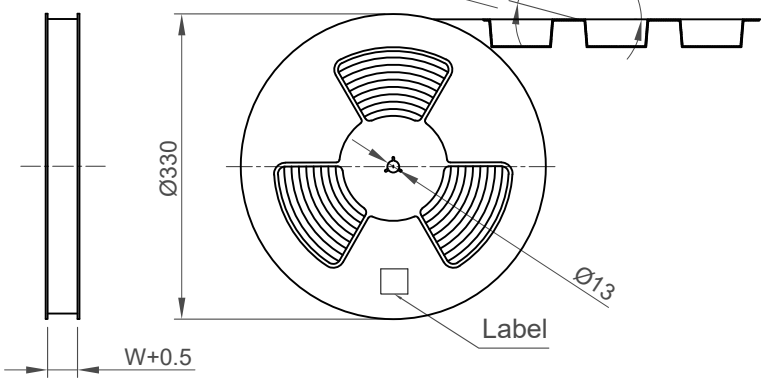

Direction of Unreeling

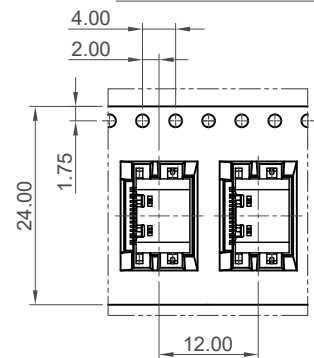

Detail: E

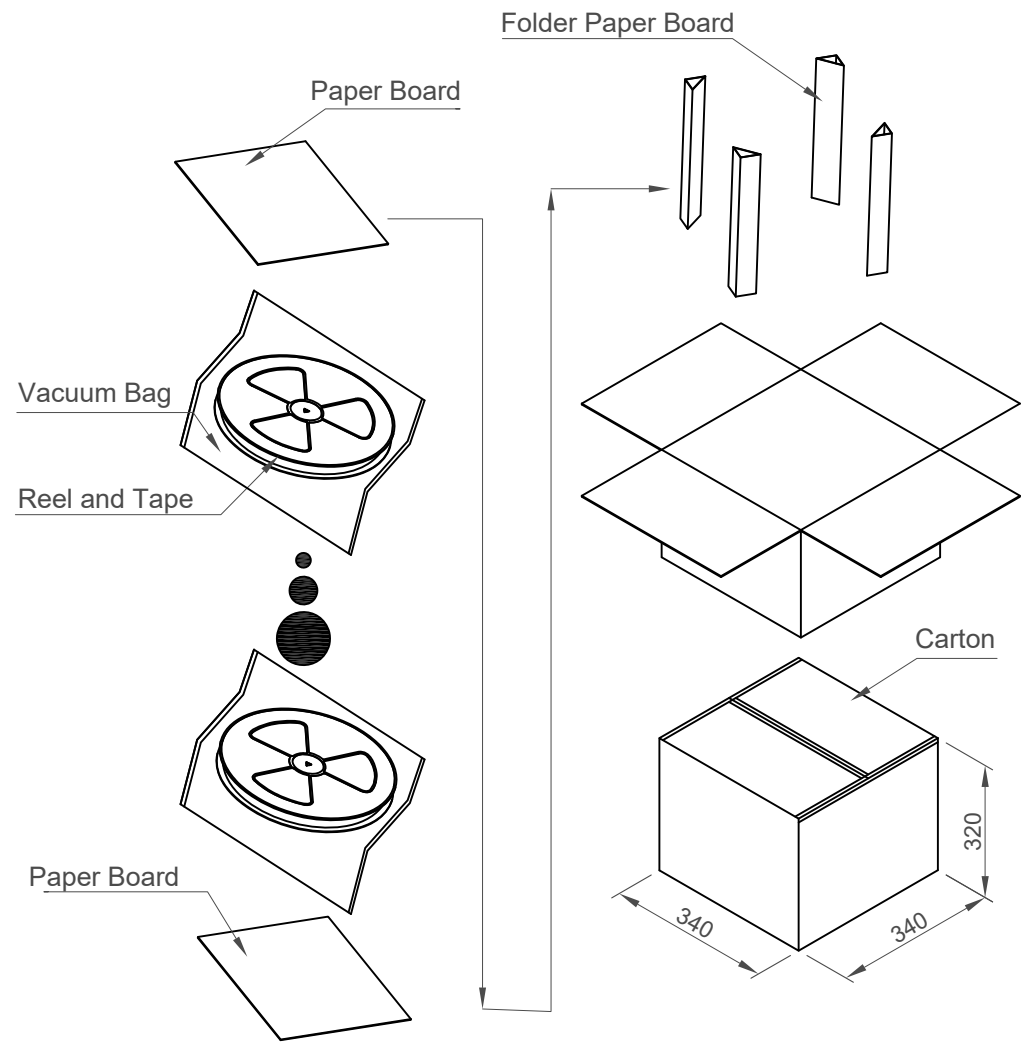

Pcs / Reel	Reels / Carton	Total Quantity
1400	10	14000 pcs

Part Number		Product Description	
USB4505		USB Type C Receptacle for USB 2.0, SMT Type, Mid Mount, 1.0mm Offset	
Drawing Date		1st July 2021	
By	CC	Tolerances (Except as Noted)	Units:
Detail	Drawing Release	Length	Metric (mm)
Revision	A2	Angle	
Date	18/12/23		



This drawing is confidential and copyright of Global Connector Technology, Ltd (GCT). This drawing must not be copied or disclosed without written consent. E & OE



Not to Scale	Drawn By CC	Sheet No. 2/2
--------------	-------------	---------------