

RECOMMENDED PCB LAYOUT  
AS VIEWED FROM COMPONENT SIDE

6 POSITIONS LOADED LAYOUT

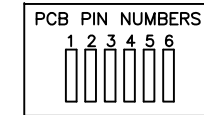

FOR 4 POSITIONS LOADED REMOVE PINS 1&6

Specification 规格:

Electrical 电气规格:

- Voltage Rating 电压额定值: 125 V AC (RMS)
- Current Rating 电流额定值: 1.5 Amp
- Contact Resistance 接触电阻值: 30mΩ Max.
- Insulation Resistance 绝缘电阻值: 1000MΩ Min. @ 500 VDC
- Dielectric Strength 电介质强度: 1000 VAC RMS 60Hz, 1 Min.

Material 物料规格:

- Housing Material 塑胶外壳: High Temp Nylon UL94V-0, Black
- Contact Material 端子材料: Phosphor Bronze 0.35mm Thickness
- Plating 电镀规格: Gold Plating over Nickel
- Operating Life 使用寿命: 750 Cycles Min.
- PCB Retention Force After Solder 焊接后保持力: 10 LBS Min.

Environmental 环境的:

- Storage Temperature 储存温度: -40°C to +85°C
- Operation Temperature 使用温度: -40°C to +85°C
- IR Reflow Soldering Temperature 回流焊接温度: 255°C to 265°C, 5-10 seconds

No. Of Positions	Positions Loaded	Dim. B
6	4	3.81
6	6	6.35

Ordering Grid

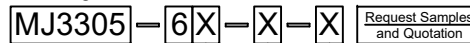

No. of Positions/  
Positions Loaded  
4 = 6/4  
6 = 6/6

Mylar Film - for pick and place

A = Without  
B = With (Standard)

Contact Plating  
2=6μ" Gold (Standard)  
4=30μ" Gold

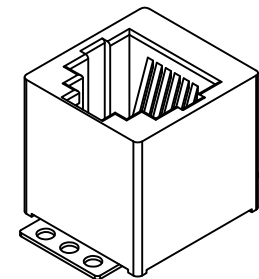

Part Number		Product Description	
MJ3305 - 6 Position		Modular Jack Connector, 6 Position, Category 3, Vertical SMT, Low Profile, with Solder Tab, without PCB Peg	
Drawing Date		11th May 2010	
By	PKN	Tolerances (Except as Noted)	Units: Metric (mm)
Detail	MJ3305 B PCN	Length X.X ± 0.20 X.XX ± 0.15 X.XXX ± 0.10	Angle ± 5°
Revision	B	3rd Angle Projection	
Date	15/06/12		
<p>This drawing is confidential and copyright of Global Connector Technology, Ltd (GCT). This drawing must not be copied or disclosed without written consent. E &amp; OE</p>			



Not to Scale	Drawn By PKN	Sheet No. 1/2
--------------	--------------	---------------

## 1. Packing Material 包材 - Tape Reel

Quantity 數量 - 1\*150=150 PCS

Tape Reel 卷帶 - Width 44 \* Depth 13.6 \* Pitch 24 = Total Length 4.1m  
 Reel 卷盤 -  $\phi 380\text{mm}$

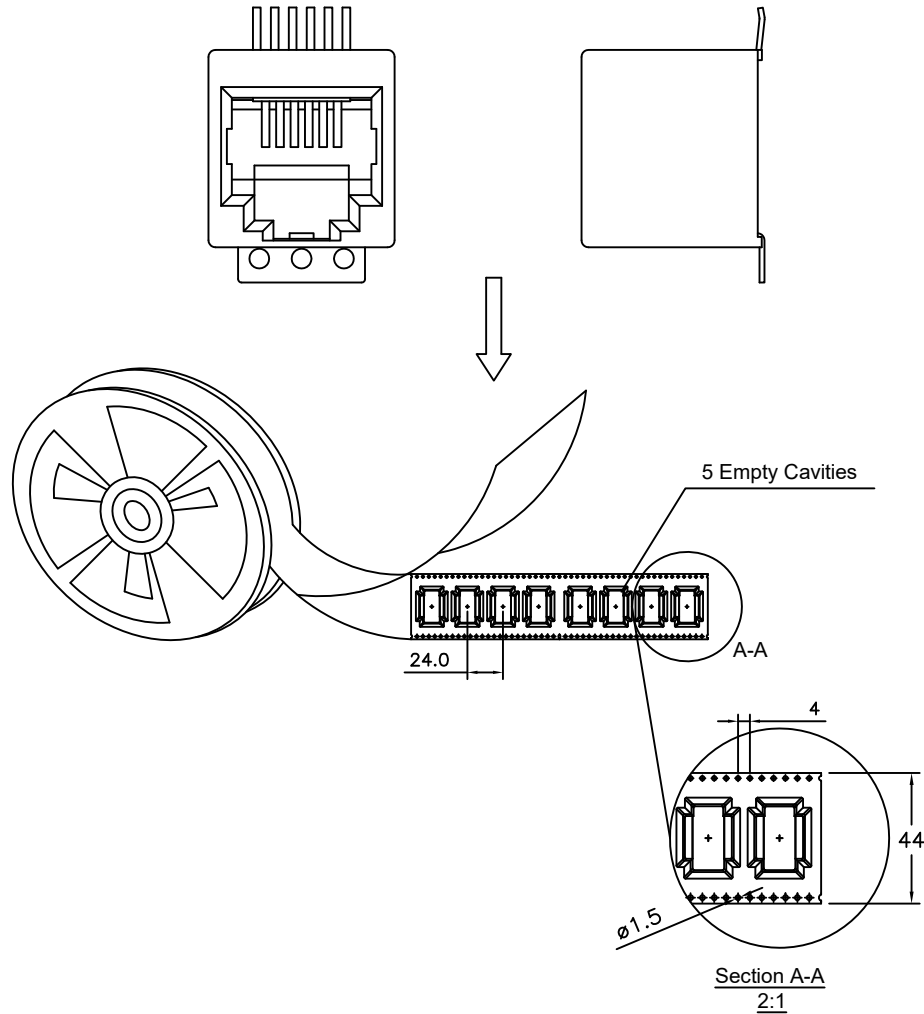



## 2. Packing Material 包材 - Carton 1 PC

Quantity 數量 - 150\*6=900 PCS

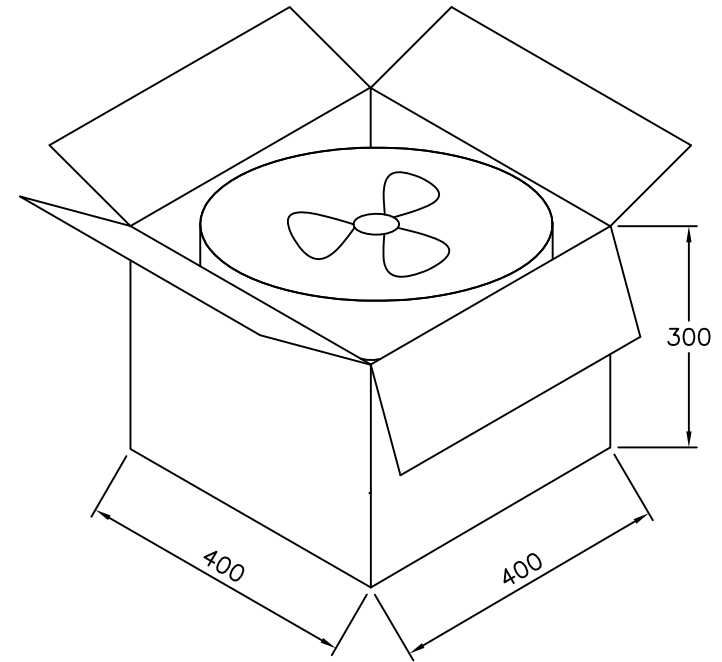
Part Number 零部件料号	Net Weight 淨重	Gross Weight 毛重	Q'TY 數量
MJ3305-64-X-X	4.50Kg	6.00Kg	900
MJ3305-66-X-X	5.50Kg	6.50Kg	900



Part Number		Product Description		 www.gct.co
MJ3305 - 6 Position		Modular Jack Connector, 6 Position, Category 3, Vertical SMT, Low Profile, with Solder Tab, without PCB Peg		
Drawing Date		11th May 2010		
By	PKN	Tolerances (Except as Noted)	Units:	This drawing is confidential and copyright of Global Connector Technology, Ltd (GCT). This drawing must not be copied or disclosed without written consent. E & OE
Detail	MJ3305 B PCN	Length	Metric (mm)	
Revision	B	Angle	 RoHS COMPLIANT 2011/65/EU Deca-SDE	
Date	15/06/12		 3rd Angle Projection	
Not to Scale		Drawn By	PKN	Sheet No.
				2/2